

COMMERCIAL VALUE

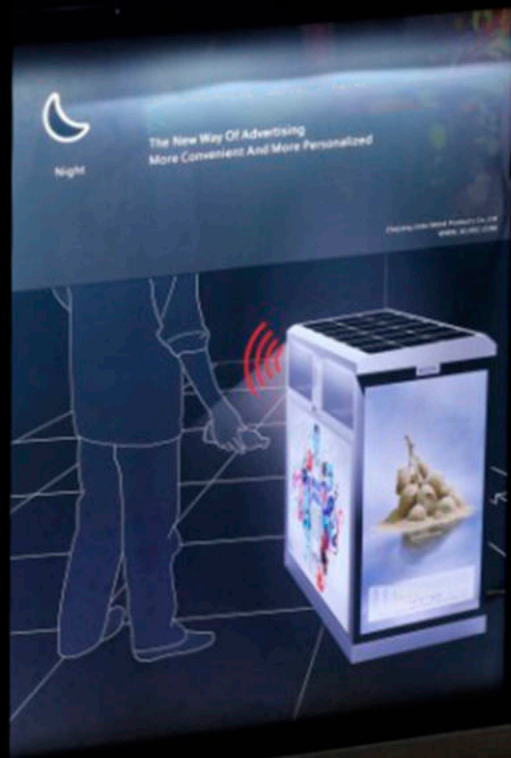

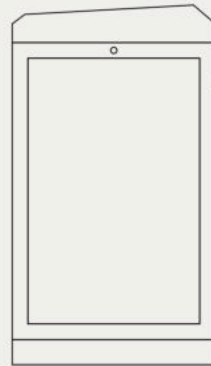

## Model: WYB2001 Hybrid Concept Capacity: 120L x 2



Smart Solar Trash + AC Power  
Smart Compactor + Bottle Receptacle  
Bench is made of Corten steel ,  
Stainless steel #304  
Thickness of 4 mm.

DESCRIPTION: Smart Trash is made of Corten steel  
Stainless steel #304  
Solar Panel 110W + AC Power  
WI-FI Router 4G: NO  
4 Led light box Advertising

FINISHES:  
Plexus box- IO55 2P USB 5V (2.1A)  
Stainless steel #201 or #304  
Thermo-lacquered in a choice of RAL

DIMENSIONS: L 1350mm x 665mm x H 1100mm - WEIGHT: 150 Kg



COMMERCIAL VALUE



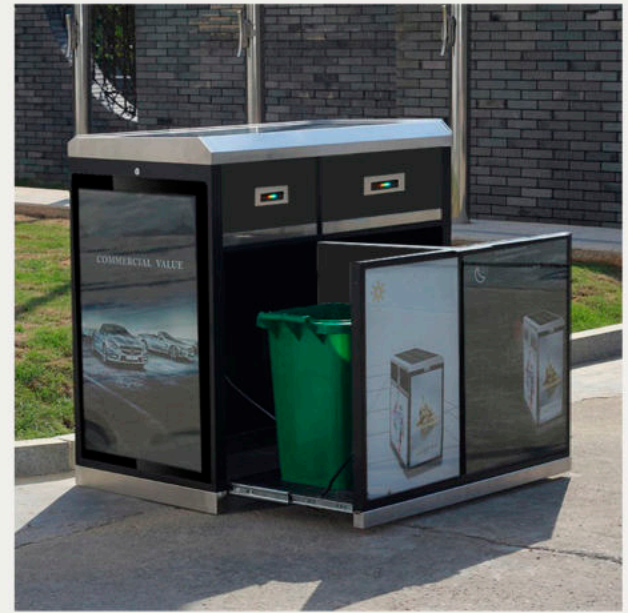
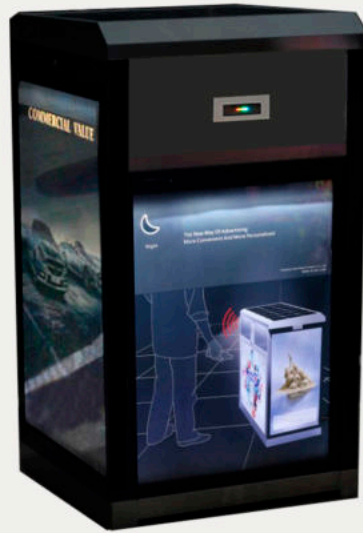

WYB2001 is a collection of Smart Solar Trash Hybrid. Easily to recycle and control trash capacity. With sensors and Platform to have the information 7D / 24Hours.

Hybrid design with solar panels and AC Power for the compactor, 4 Led Light box left, right and front for posters and advertising. Perfect to expand the business by renting that space for advertising.

Perfect for parks, streets, bus stops, train stations, campuses, shopping centers and others.

Anchoring of installations to the ground and steel casing: resistance to vandalism



**Intelligent Compactor + Bottle Receptacle  
Hybrid System: Solar + AC Power**

Material: Stainless steel #304  
 Dimensions: L-135cm, W-66.5cm, H-110cm  
 Capacity: 120L x 2  
 Solar panel: 110W  
 Battery: 12V/100AH  
 LED Strip Light RGB/W  
 Sensor control capacity  
 Sensor for door opening/Voice Broadcast  
 Filled alarm  
 2 Led light Box Advertising (Left and right)  
 2 Led light box Advertising front side

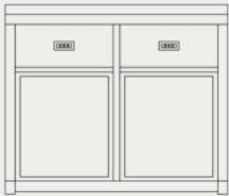
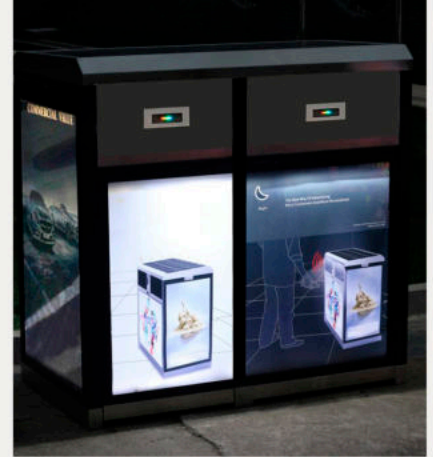
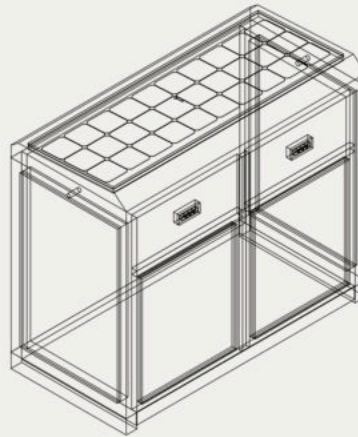

135\*66.5\*110



Sensor Capacity

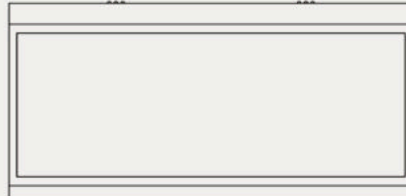

Smart Compactor

Solar Panel 110W

**Smart City: All smart components controlled by our Platform Adlis Smart.**  
 Control, configure, receive alarms from the Platform or our APP for each Smart Products placed on the street

Can be upgraded and customized for specific applications  
 Custom colors available  
 Vandal resistant

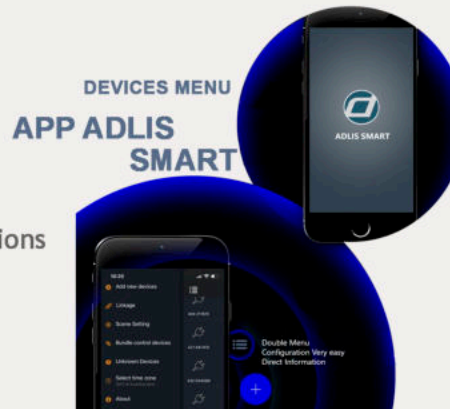

**ADLIS/WEIYIN CORPORATION**

Visit our website for product details, color charts technical sheets, sales office locations, Download JPG images, brochure PDF, Data Sheet, CSI specifications.

<https://www.adlissmart.com>  
<https://www.adlis.co.il/>  
<https://www.solarbenchchina.com/>  
<https://www.adlis.co.il/SmartBench/>  
<https://www.adlis.co.il/Marketing/>

WYB2001 Design: Adlis Smart  
 WYB2001 is manufactured in Israel and China  
 Location Photography: Chile, Grecia, greece

Specifications are subject to change without notice.  
 3D Design / Artwork for the 21st century  
 ©2020 Adlis/WeiYin Corporation

Office: Sderot Moriah 104, Haifa - Israel  
 Factory: Asher 4 Kiryat Yam - Israel  
 2/F, Building E, Hengchangrong Industrial Park,  
 Pinghu Street, Longgang District, Shenzhen City,  
 Guangdong Province, China



We Don't Make The Future, We make The Future Better.